

# **NOTEBOOK COMPUTER**

**RT786**

**USER'S GUIDE**

Copyright © 2003

All rights reserved. No part of this publication may be reproduced, transmitted, transcribed, stored in a retrieval system, or translated into any language, or computer language, in any form, or by any means, electronic, mechanical, magnetic, optical, chemical, or other, without the prior written permission of the manufacturer.

The manufacturer reserves the right to revise this publication and to make changes to the contents hereof without obligation to notify any person of such revision or changes.

The manufacturer makes no representations or warranties, either expressed or implied, with respect to the contents hereof and specifically disclaims any warranties as to merchantability or fitness for any particular purpose. Any of the software described in this manual is sold or licensed "as is". Should the programs prove defective following purchase, the buyer (and not the manufacturer, its distributor, or its dealer), assumes the entire cost of all necessary servicing, repair and any incidental or consequential damages resulting from any software defects.

#### Trademark Acknowledgments

IBM, PC, AT, XT are registered trademarks of International Business Machines Corp.

MS-DOS and Windows are registered trademarks of Microsoft Corp.

Pentium is the registered trademark of Intel Corp.

All product and company names are trademarks or registered trademarks of their respective holders.

# **EMC and Safety Notice**

## **Federal Communications Commission Radio Frequency Interference Statement**

This equipment generates, uses, and can radiate radio frequency energy. If not installed and used in accordance with the instructions, this equipment may cause interference to radio communications. This equipment has been tested and found to comply with Class B digital devices, pursuant to Part 15 of the FCC rules, which were designed to provide reasonable protection against such interference when operated in commercial or residential environments.

### **Countermeasures if interference occurs**

The following steps often eliminate interference, and are recommended if interference occurs while the device is in operation:

1. Turn OFF the computer and unplug the AC adapter from the outlet. If interference continues, refer to the next step.
2. Connect the AC adapter to an outlet in another room, and test for interference. If interference continues, refer to the next step.
3. Connect the system to an outlet far away from the interfered appliance. If interference continues, refer to the next step.
4. Re-orient your computer in respect to the interfered appliance to see if there is improvement.

If these steps failed to solve interference complications, please call your dealer for help.

### **CE**

This equipment complies with the requirements set out in the Council Directive on the Approximation of the laws of the Member States relating to Electromagnetic Compatibility (89/336/EEC). For the evaluation regarding the electromagnetic compatibility, the following standards were applied:

- EN55022 EMI Conduction and Radiation
- EN61000-3-2 Harmonics
- EN61000-3-3 Flicker (Voltage fluctuation)

EN55024 EMS

EN61000-4-2 ESD (Electrostatic discharge)

EN61000-4-3 RS (Radio frequency electromagnetic field)

EN61000-4-4 EFT (Electrical fast transient/burst)

EN61000-4-5 Surge

EN61000-4-6 CS (Conducted disturbances induced by radio frequency)

EN61000-4-8 Power-Frequency Magnetic Field

EN61000-4-11 Voltage Dips and Voltage Interruptions

## **UL, TÜV**

AC Adapter (TÜV includes EN60950 LVD)

## **E-Mark**

Registered: e13 021824

## **Power Conservation**

This computer consumes much less power than conventional computers; however, power consumption may be reduced by properly configuring the Power Management Setups.

It is recommended that the power saving functions be enabled even when not running on battery power.

Power Management generally does not degrade system performance while saving power.

## **Material Safety and Recycling**

All materials used in the construction of this unit are recyclable or environmentally friendly. No CFC or related materials were used in the manufacturing process or inside the product.

Please recycle the packing materials, and at the end of the computer's life, all other materials in accordance with the local regulations.

Please refer "Material and Recycling" for the contents of the materials.

# CONTENTS

<b>GETTING STARTED .....</b>	<b>1</b>
UNPACKING .....	1
QUICK OPERATION .....	2
CONTROLS AND INDICATORS .....	3
<b>USEFUL INFORMATION.....</b>	<b>7</b>
LOCATION.....	7
RUGGEDNESS.....	7
OPERATING SYSTEMS.....	8
AC ADAPTER .....	8
BATTERY.....	9
BOOT UP AND POST .....	10
STANDBY/HIBERNATE/RESUME.....	11
SHUTDOWN.....	11
RTC.....	11
REPLACING MODULES .....	12
<b>COMPONENTS AND FUNCTIONS.....</b>	<b>13</b>
KEYBOARD.....	13
FLOPPY DISK DRIVE .....	14
PRINTER CABLE.....	14
HARD DISK DRIVE.....	14
CD-ROM DRIVE.....	15
PCMCIA CARDS.....	15
DOCKUNDER (OPTIONAL).....	15
<b>OPTIONAL DEVICES.....</b>	<b>20</b>
MEMORY CARD.....	20
2 <sup>ND</sup> BATTERY.....	20
LAN AND FAX/MODEM CARD .....	20

WIRELESS LAN CARD .....	20
DVD ROM DRIVE .....	20
CD-RW DRIVE.....	20
DVD-RW DRIVE .....	20
2 <sup>ND</sup> HDD.....	20
TOUCH SCREEN .....	21
PCMCIA COVER .....	21
VEHICLE ADAPTER.....	21
DUAL BATTERY CHARGER.....	21
DOCKUNDER .....	21
<b>SPECIFICATIONS.....</b>	<b>23</b>
CPU.....	23
MEMORY .....	23
DISPLAY .....	23
KEYBOARD.....	24
FLOPPY DISK DRIVE .....	24
HARD DISK DRIVE .....	24
CD-ROM DRIVE.....	24
TOUCH SCREEN .....	24
I/O PORTS .....	25
AC ADAPTER .....	25
VEHICLE ADAPTER.....	25
BATTERY.....	26
SYSTEM UNIT DIMENSIONS AND WEIGHT .....	26
MATERIALS AND RECYCLING .....	26
ENVIRONMENTAL .....	27
<b>BIOS SETUP .....</b>	<b>28</b>
MAIN MENU.....	28
ADVANCED MENU .....	30
I/O DEVICE CONFIGURATION SUB-MENU .....	30
SECURITY MENU.....	31

POWER MENU.....	33
BOOT MENU.....	33
EXIT MENU.....	34
<b>UTILITIES AND DRIVERS.....</b>	<b>35</b>
VGA UTILITY .....	35
DISPLAY CAPABILITY.....	35
MOUSE DRIVER.....	36
TOUCH SCREEN DRIVER.....	36
CD-ROM DRIVER.....	36
PCMCIA DRIVER.....	37
AUDIO DRIVER.....	37
LAN CARD DRIVER.....	37
FAX/MODEM CARD DRIVER.....	37
<b>MAINTENANCE / SERVICE.....</b>	<b>38</b>
CLEANING.....	38
TROUBLESHOOTING.....	38
RMA SERVICE.....	38

## GETTING STARTED

### Unpacking

The following components come with your computer. If anything is missing or damaged please notify the dealer immediately.

- Computer unit
- Removable FDD or CD-ROM (one of them is installed on computer and the other as accessory)
- AC Adapter
- AC Power Cord
- Utility Diskettes or CD
- User's Guide
- External Keyboard Adapter Cable
- Printer adapter cable
- Carrying Bag

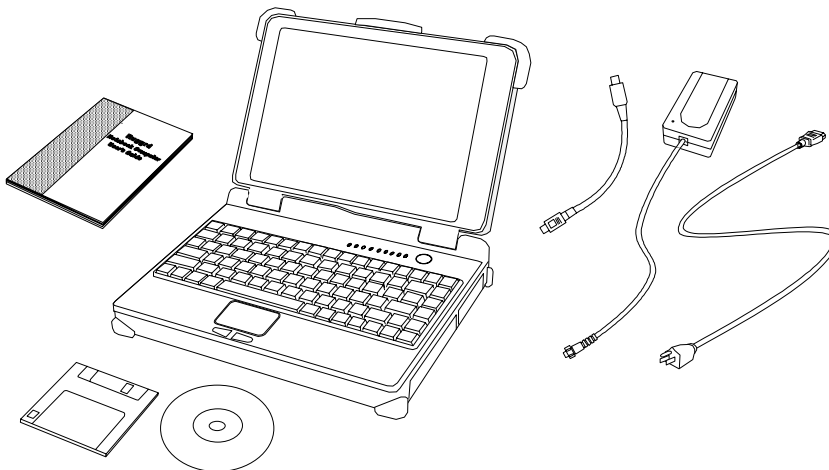

### Quick Operation

- Loosen the battery screw, remove the battery insulation sheet, and then reposition the battery for operation.
- Attach the AC adapter and charge battery for at least 10 minutes.
- Turn ON the computer by pressing the power switch momentarily.
- Turn OFF the computer using either one of the following procedures:
  1. Press power switch to “Shut down”, “Standby”\* or “Hibernate”\* dependent on operating system (OS) and power management settings.
  2. Press power switch for 4 seconds for a “Hard” power off. System shuts down immediately without saving any data or parameters.

*\*: Some operating systems may not support these functions.*

3. Click **Start** → **Shut Down** in Windows to turn OFF.

Driver or application software installation may be necessary for further operation.

## Controls and Indicators

### Controls and Indicators (Upper)

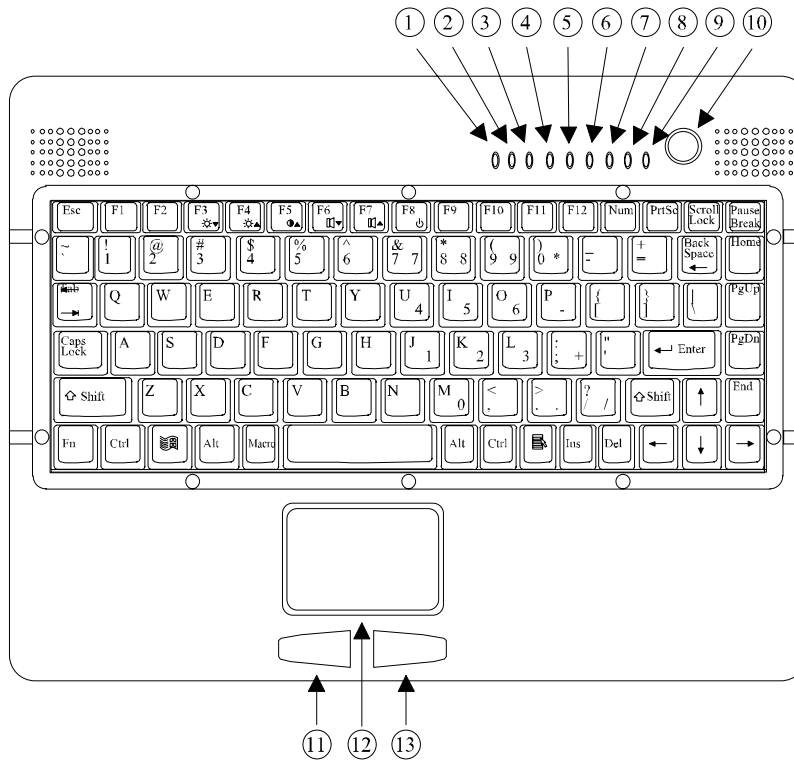

1. (Reserved)
2. PCMCIA
3. Keyboard Number Lock
4. Keyboard Caps Lock
5. Keyboard Scroll Lock
6. HDD in use
7. Secondary Battery Charge
8. Primary Battery Charge
9. Power indicator
10. Power switch
11. Touch pad left button

- 12. Touch pad
- 13. Touch pad right button

**Controls and Indicators (Right)**

**FDD Configuration:**

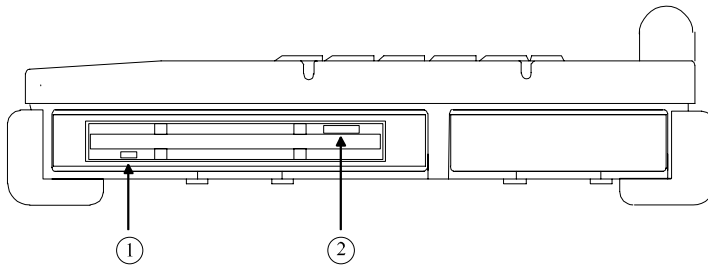

- 1. FDD in use
- 2. Diskette eject button

**CD-ROM Drive Configuration:**

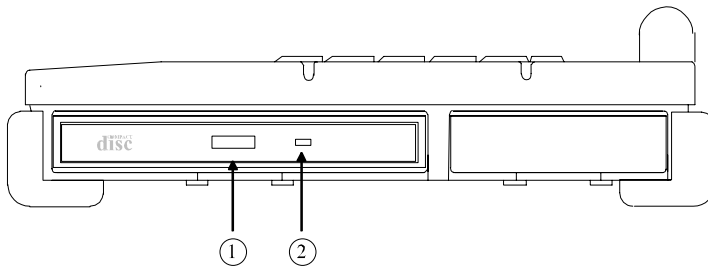

- 1. CD-ROM eject button
- 2. CD-ROM in use

**2<sup>nd</sup> Battery Configuration: (optional)**

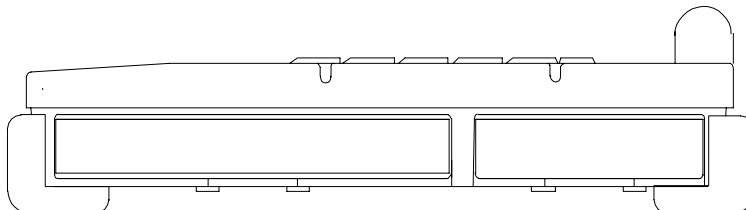

No special control or indicator.

---

**Controls and Indicators (Left)**

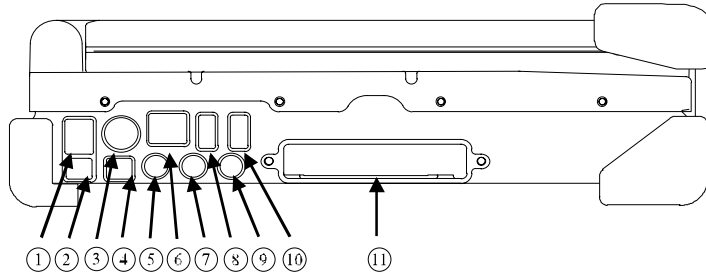

1. Phone Jack
2. IEEE1394 port (Fire Wire)
3. External Keyboard + PS/2 port
4. IEEE1394 port
5. External Speaker
6. LAN Jack
7. Line In port
8. USB port
9. Microphone port
10. USB port (Universal Serial Bus)
11. PCMCIA slots

**Controls and Indicators (Rear)**

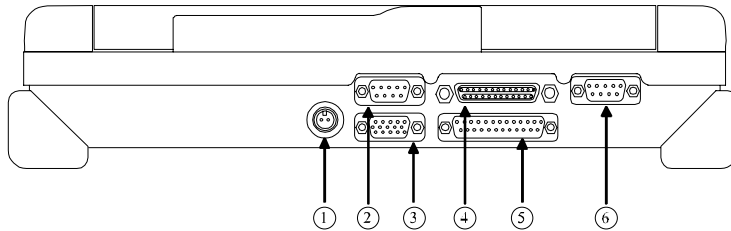

1. DC Power Jack
2. Serial Port COM1
3. External RGB Monitor Port
4. Docking Port

5. Printer/External FDD Port\*
6. Serial Port COM2 (or COM3 by optional configuration)

*\*: The port is a dual function port and default as printer output. System will detect the device attached then switch to proper output automatically. Hot swap is possible under most conditions. However, if unable to hot swap, please re-boot computer with the new device attached.*

## USEFUL INFORMATION

### Location

A clean and moisture-free environment is preferred. Make room for air circulation. Avoid areas with:

- Sudden or extreme changes in temperature.
- Extreme heat.
- Strong electromagnetic fields (near television set, motor rotation area, etc.).
- Dust or high humidity.

If it is necessary to work in a hostile environment, please regularly maintain your computer by cleaning dust, water, etc. to keep it in optimal condition.

### Ruggedness

The computer is designed with rugged features such as vibration, shock, dust, and rain/water protection. However, it is still necessary to provide appropriate protection while operating in harsh environments.

The computer is designed to withstand rainfall from top with mild wind blowing only. Please keep the keyboard facing up, i.e., normal operating direction, to maintain water resistance. NEVER immerse the unit in water, or spray water at an upside-down system. Doing so may cause permanent damage.

The D-sub connector caps on the rear of the computer are for dust and shock protection. The connectors are sealed internally. Other I/O ports and devices on the left or right must have caps tightly closed or cable inlets sealed while exposed to water or dust.

There are optional gaskets for DB-9 and DB-25 connectors. You may install them to improve rain/dust/moisture resistance on your commercial type cable. Insert the packing into the male connector (with pins) and fasten the screws.

All connectors will be corroded if exposed to water or moisture. Corrosion is accelerated if the system's power is ON. Please take proper water-resistant measures for cable connections.

The DC jack and cables are sealed and may be operated with water splashing while attached. All port covers should be in place when no cable is attached.

## Operating Systems

The computer is compatible with most operating systems (OS). However, not all functions are 100% compatible.

For example, ACPI, APM, Smart Battery, etc. are not available on DOS, Windows NT, and other non-Microsoft OS. Consequently “Standby”, “Hibernation”, “Battery Gauge” etc. would not work under such operating systems.

*ACPI: Advanced Configurations and Power Interface*

*APM: Advanced Power Management*

## AC Adapter

The AC adapter performs two functions:

- It powers the computer from an external AC source.
- It charges the computer battery.

The adapter automatically detects the AC line voltage (110V or 220V) and adjusts accordingly.

The following are recommended when using the AC adapter:

- Use a properly grounded AC outlet.
- Use one AC outlet exclusively for the computer. Having other appliances on the same line may cause interference.
- Use a power strip with built-in surge protection.

Connect the AC adapter:

1. Plug the AC cord to the adapter.
2. Plug the other end of the AC cord into the wall outlet. Make sure the green LED on the adapter turns on.
3. Attach the DC plug into the power jack of the computer; turn the lock ring clockwise to secure it.

## AC Adapter Indicator

The green LED indicates that the AC power is ready.

## **Battery**

The computer will automatically switch to battery power when the external power source (AC adapter or optional vehicle adapter) is disconnected.

### **Battery Power Saving Tips**

The computer comes with an intelligent power-saving feature. You may extend the battery life by:

- Setup power saving functions in Operating System Power Management options (e.g. Windows 98/2000/ME/XP Power Options).
- Lower the intensity of the display by brightness control.
- Use standby option when computer is temporarily not in use.
- Shut down the computer when it will not be in use for long periods of time.

### **Battery Low**

When the battery is nearly exhausted, the computer gives the following “Battery Low” warnings:

- Windows 98/2000/ME/XP battery low warning (when operating system is Windows)
- A series of beeps.
- The power LED flashes.

Once the Battery Low warning occurs, please:

1. Save and close the files you are currently working on.
2. Plug in the AC adapter to recharge the battery.

### **Battery Gauge**

In Windows 98/2000/ME/XP, etc. you may check battery status information from battery gauge. Click the power/battery icon to reveal the battery gauge window.

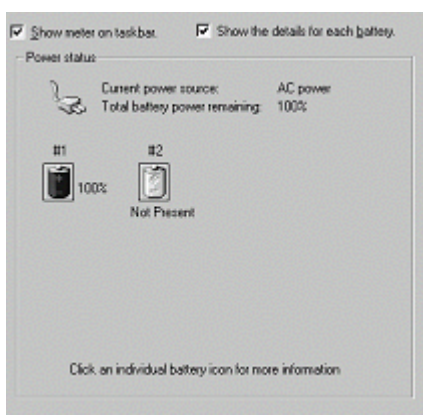

*Note: Battery characteristic varies depending on factors such as ambient temperature, charging method, load current, aging, etc.  
For example, at low temperature the chemicals of the battery are more inactive, thus decreases the output power.  
The battery gauge should only be used as a reference. Please do not expect it to show the exact amount of the power remaining.  
There is no memory effect on Lithium Ion battery cells. However, discharge the battery to nearly empty every month will help calibrate the internal gauge.*

### **Charging the Battery**

Plug in the AC adapter (or optional vehicle adapter) to start the battery charging. If the battery is already full, the sense circuitry will stop high current charge within several minutes.

There are two LED indicators next to the power indicator for the Primary and Secondary battery respectively. Indicator turns ON when the battery is charging and turns OFF when the battery charge is completed.

To charge the Secondary Battery, simply install it into the computer and attach the AC adapter. The internal charger will charge the Primary and Secondary batteries simultaneously.

Optional Dual Battery Charger can charge Primary and Secondary batteries externally.

### **Boot Up and POST**

The computer turns ON and loads the operating system (such as Windows) into the system memory. This start-up procedure is called "boot up".

### **The ROM BIOS Power On Self-Test (POST)**

Each time the computer powers on, it automatically performs a self-test of its memory and hardware devices.

### **Standby/Hibernate/Resume**

The system can enter standby or hibernate mode by either pressing the power switch or staying idle till timeout.

*Note: Standby/Hibernate/Resume works with both AC adapter and battery. The power management functions may not work under Windows NT or non-Windows operating systems.*

### **Shutdown**

The following procedure is recommended in shutting down the computer:

1. Save any work you want to keep.
2. Make sure none of the disk drives are active (HDD, FDD, and CD-ROM drive).
3. Remove any diskettes, CD-ROMs, or other media if necessary.
4. Follow the shut down procedure of your operating system.
5. Let the computer shut down or push the power switch to turn OFF.

Failure to shut down the computer properly may result in loss of data or hardware damages.

Automatic shut down is activated at battery exhaust. Be sure to finish your work and save all your data when the battery low warning appears.

### **RTC**

Battery backed up RTC (Real Time Clock/Calendar) is built in an on-board CMOS (Complementary Metal Oxide Semiconductor) chip. The RTC keeps track of the time and date while the computer is off. The CMOS chip also stores system setup information.

RTC battery is also recharged when AC adapter is attached. Recharge the computer approximately once per month to ensure RTC operation.

---

## Replacing Modules

*Caution! You must turn the power OFF before replacing the FDD, CD-ROM, and HDD modules.*

To remove the modules:

1. Turn OFF the computer or hibernate (suspend to disk).
2. Disconnect all cables from the computer.
3. Use a coin to turn loose the screws on the modules.
4. Remove the battery from the compartment.
5. Push the latch knob to release the CD-ROM or HDD module and push them outward.
6. Remove the module from the computer.

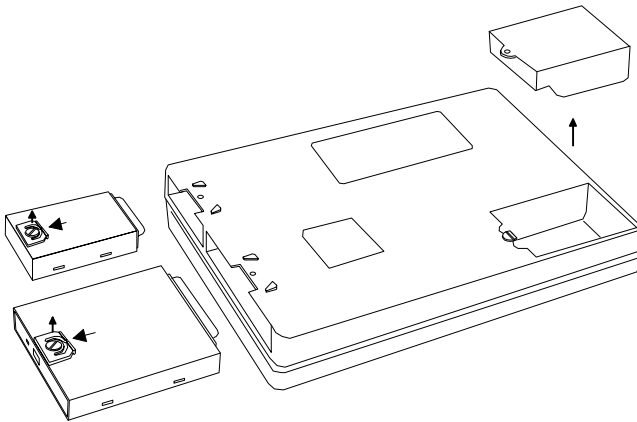

To re-install the modules:

Gently push the module into the slot. Fasten the screw to fix the module.

## COMPONENTS AND FUNCTIONS

### Keyboard

The keyboard is functionally equivalent to a full size desktop keyboard. A sample key layout is shown below.



### The Numeric Keypad

The numeric keypad functions like an electronic calculator. It is embedded in the main keyboard, with the numeric figures printed on the upper right of their respective keys. The keypad has keys for the digits 0 through 9, the decimal point (.), addition (+), subtraction (-), multiplication (\*), and division (/).

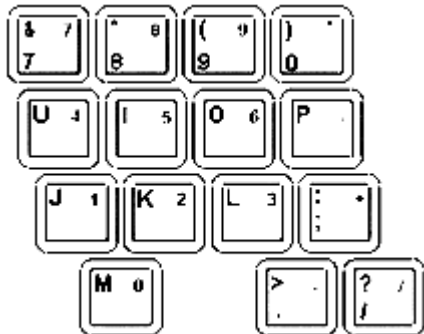

To activate the keypad, press the Num Lock key. The 15 keys shown in the figure switch from alphabetic keys to numeric keys. Press Num Lock again to return to alphabetic.

### Keyboard Backlight (optional)

Press [Fn] [F5] key for approximately 1 second turns keyboard backlight ON or OFF.

### Floppy Disk Drive

The computer comes with a 3.5" 1.44MB floppy disk drive (FDD). The 1.44MB FDD can also read and write 720KB double side double density diskette. It is recommended that high density (2HD marking) diskette been used only.

FDD can be removed and swapped with CD-ROM drive or 2<sup>nd</sup> battery. When CD-ROM drive or 2<sup>nd</sup> battery is installed, you may still use FDD by connecting it via the rear DB-25 port.

### Printer Cable

For most printers there is no special requirement in connection. However, some printer cables do not contain all 25 wires. To avoid malfunction, the printer adapter cable comes with your computer should be attached to the printer cable. The purpose is to re-connect all the ground pins. Devices equivalent to printer such as scanner, Laplink cable, etc. also need this cable.

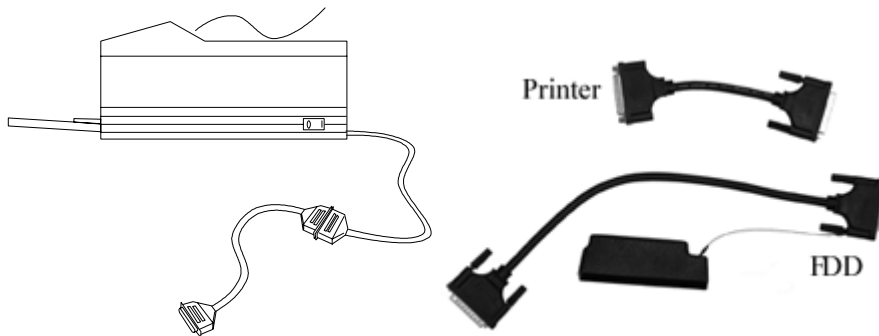

Please note do not use the FDD cable as printer adapter cable.

### Hard Disk Drive

The Hard Disk Drive (HDD) is a 2.5" type standard IDE interface data storage device.

HDD and FDD, CD-ROM drives are removable. This provides convenience and security. They can ONLY be removed while the power is OFF.

*Note: NEVER drop your HDD, FDD, CD-ROM module or expose them to high temperature, high humidity, or any hazardous environment. NEVER try to disassemble the module.  
Static discharge may destroy your device and data. Always pick up the modules by touching the case only.*

### **CD-ROM Drive**

The CD-ROM drive is a standard IDE ATAPI type, which accepts a variety of standard 12cm CDs such as CD-ROM, audio CD, CD-I, Photo CD, video CD, etc.

The following procedure assumes that all the necessary CD-ROM utilities were installed on the computer. For CD-ROM utility installation, please refer “**Utilities and Drivers**”.

#### **Put CD into CD-ROM drive**

While the power is ON, push the CD-ROM drive's eject button. The tray will release. Then gently pull the tray out. Put the CD on the holder and push the tray back into the cabinet. Any dirt on the data side of the CD may cause read error. Please do not touch this side when handling CDs.

#### **Read from CD-ROM drive**

The CD-ROM drive may be designated as drive D: or higher depending on your configuration. You may access it in DOS or Windows the same way you would for the floppy disk drive or hard disk drive. The CD-ROM is a read-only device. Any command attempting to write onto it will be denied.

Please avoid shock or vibration while the CD-ROM drive is active.

### **PCMCIA Cards**

The computer supports two type-II PCMCIA cards or one type-III card. To remove the card, push the button on the right of the card to eject it. The eject button can hide into the compartment by pushing it inward gently.

### **Dockunder (optional)**

Dockunder is utilized for system unit docking. The AC adapter or vehicle adapter attaches directly to Dockunder and automatically charges the computer while docked.

Ports (horizontal version, ports on rear)

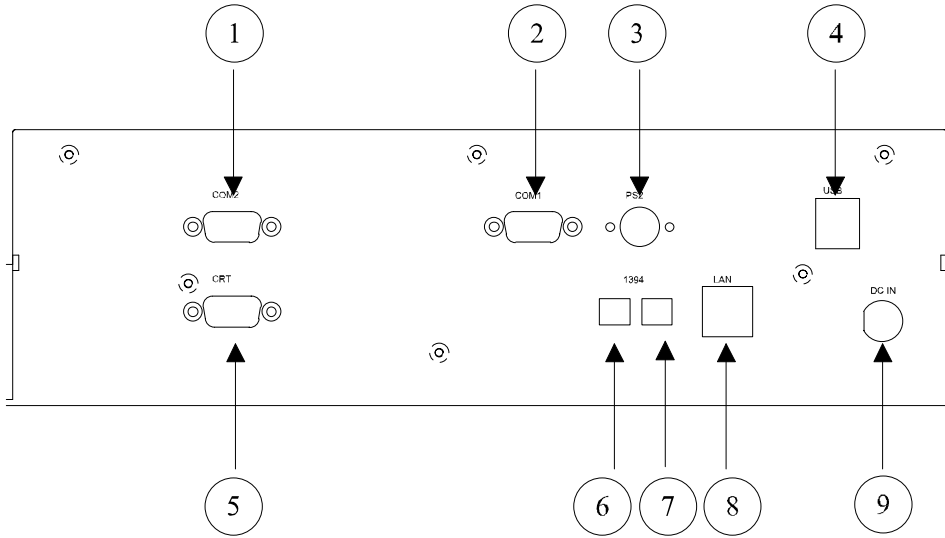

1. COM2
2. COM1
3. PS/2
4. USB #1 & #2
5. RGB
6. IEEE1344 #1
7. IEEE1394 #2
8. LAN
9. DC jack

**Ports (vertical version, ports on bottom)**

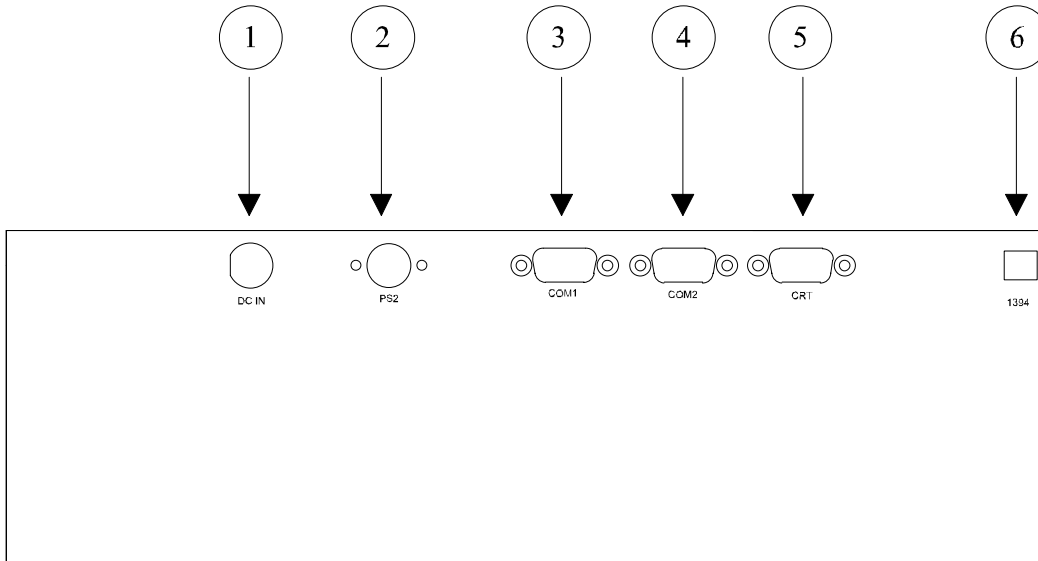

1. DC jack
2. PS/2
3. COM1
4. COM2
5. RGB
6. IEEE1394

**Mount the Dockunder:**

1. Turn OFF the power.
2. Open the rubber cap of the docking connector.
3. Align the docking connector.
4. Push the computer to join the guiding pins. Do not lift the computer up while docking.

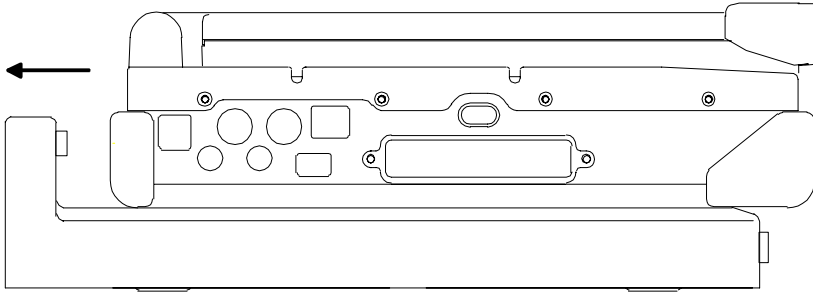

*Note: Do not lift up the computer while engaging.*

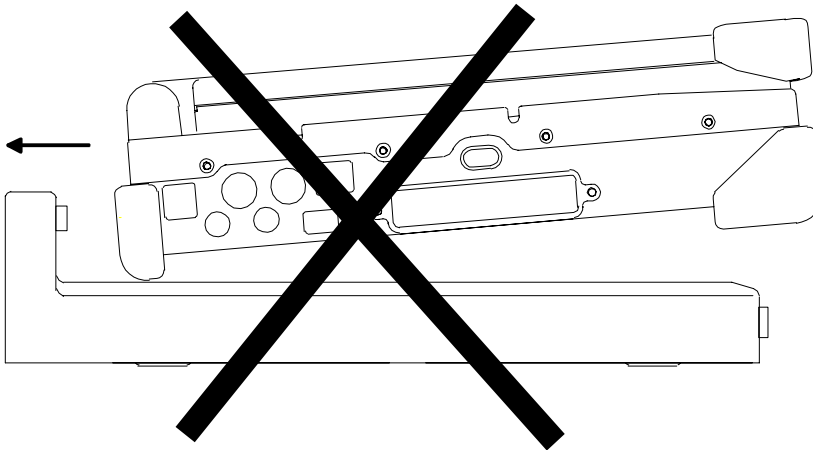

5. Lock the computer.

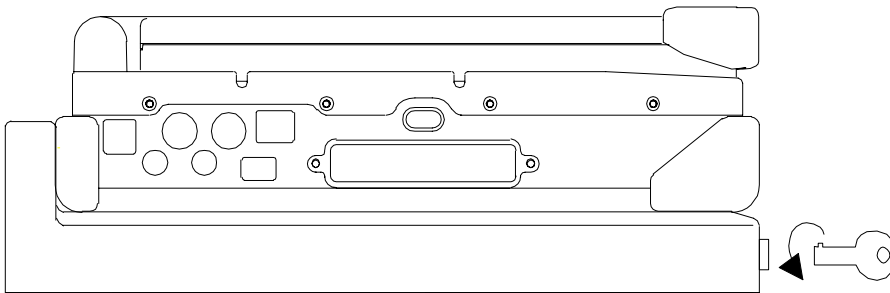

There is 2 PCI slots on the Dockunder. Maximum card dimensions are 260mm (L: length, including L-bracket thickness) x 115mm (W: width, including gold fingers) x 25 mm (H: height). The total power rating of 2 PCI slots is +5V 3A, +3.3V 3A, +12V 300mA, -12V 300mA.

To install expansion card in Dockunder:

1. Unplug the AC adapter.

2. Release and remove the computer.
3. Remove the screws on the upper and lower covers.
  1. Open the upper cover.
  2. Install the expansion card into the slot and fix the L-bracket.
  3. Assemble the upper cover.
  4. Attach the computer and perform functions test.

*Note: Please check IRQ conflict before installing cards and drivers.  
Never dock or un-dock the computer while power is ON.*

	IRQ	DMA
0	Timer output 0	0 Sound
1	KB	1 Sound
2	8 RTC	2 FDD
	9 ACPI (or Free)	3 Reserved (or ECP/EPP)
	10 Free (16-bit PCMCIA, or COM3*)	
	11 PCI devices or Card Bus 0/1 (Sound, LAN*, 32-bit PCMCIA, etc.)	
	12 Touch pad (PS/2 mouse)	
	13 Co-processor	
	14 HDD	
	15 CD-ROM drive	
3	COM2 (or Fax/Modem*, IrDA)	
4	COM1 (or Touch screen)	
5	Free (COM4*)	
6	FDD	
7	Parallel port 1	

\*: Optional devices.

## OPTIONAL DEVICES

### Memory Card

The memory card will expand your memory to facilitate better system performance. The cards are available as following:

256MB, 512MB

### 2<sup>nd</sup> Battery

A Lithium Ion rechargeable 2<sup>nd</sup> battery may install into the CD-ROM/FDD compartment. It has the same capacity of primary battery and Smart Battery compliance.

The computer's internal charger can detect 2<sup>nd</sup> battery and perform charging accordingly.

### LAN and Fax/Modem Card

100 Base-T Ethernet LAN card for a wired network and V.90 56K Fax/Modem.

### Wireless LAN Card

IEEE 802.11b wireless LAN card and rugged antenna.

### DVD ROM Drive

Swappable with CD-ROM drive for DVD playback. Backward compatible with CD-ROM, VCD, etc.

### CD-RW Drive

Swappable with CD-ROM drive for writing CD-R. Backward compatible with CD-ROM, VCD, etc.

### DVD-RW Drive

Swappable with CD-ROM drive for DVD playback and writing CD-R. Backward compatible with CD-ROM, VCD, etc.

### 2<sup>nd</sup> HDD

Swappable with CD-ROM drive. Set as IDE secondary master drive.

## **Touch Screen**

Resistive or capacitive touch screens for direct finger touch or pen input instead of mouse or touch pad.

*Note: Capacitive touch screen requires a “grounding” to work properly. Otherwise it will not activate when touched. Generally the grounding is sufficient if the AC adapter is attached or the computer/panel is mounted on a vehicle’s metal parts. Holding the computer/panel with the other hand the human body will act as grounding, too.*

## **PCMCIA Cover**

Besides the attached PCMCIA rubber cover, there is an optional cover with a metal frame that can be fixed using screws. The cover provides protection from dust or water for cabled PCMCIA cards. Users may seal the cable outlet after installation.

## **Vehicle Adapter**

Converts power from car lighters or truck batteries to DC +19V, the same output ratings as AC adapters. It can power the system and charge the batteries simultaneously.

*Remove or disconnect the adapter when leaving the vehicle to avoid battery exhaustion.*

## **Dual Battery Charger**

This charger provides two slots for the Primary and Secondary battery respectively. It allows charging of both batteries simultaneously. Accepts power from AC adapter or Vehicle adapter. It takes approximately 3 hours to fully charge both batteries.

## **Dockunder**

3 models are available:

Dockunder RT7-H: (no hot docking)

2 PCI slots, serial ports x 2, USB (v.2.0) x 2, 1394 x 2, PS/2, RGB, LAN.

Ports are on the rear.

*Hot docking: Docking while computer power is ON.*

Dockunder RT7-V: (no hot docking)

2 PCI slots, serial ports x 2, USB (v.2.0) x 2, 1394 x 1, PS/2, RGB.

Ports are on the bottom.

Dockunder RT7-V2: (hot docking)

No PCI slots, serial ports x 2, USB (v.2.0) x 2, 1394 x 1, PS/2, RGB.

Ports are on the bottom.

## SPECIFICATIONS

### CPU

Intel Mobile Pentium 4

CPU runs at 2 speeds:

High speed (AC adapter mode)

Low speed (Battery mode)

The CPU speed switches automatically by detecting AC adapter attached.

### Memory

**System memory**                    Minimum: 256MB  
   Expandable: 512MB, 768MB, 1GB

**Cache memory**                    Internal level-2 512 KB

**Video memory**                    32MB (optional 64MB)

### Display

The display is a SVGA compatible LCD (Liquid Crystal Display) of 800 x 600 dots (horizontal x vertical) or 1024 x 768 dots with 16, 24 or 32 bit color depth. The computer is capable of displaying 2048 x 1536 dots on the LCD or external monitor.

LCD applies a “Panning” technique to display resolutions higher than 800 x 600 or 1024 x 768 dots. In Panning, you may move the cursor out of the screen boundary, then the display will scroll to show the hidden area.

### LCD:

Type:	12.1” Active TFT Color 13.3” Active TFT Color
Resolution:	800 x 600 pixels (12.1”) 1024 x 768 pixels (13.3”)
Mode:	VGA, EGA, MGA, SVGA, and XGA
Color:	16, 24 or 32-bit color depths on all modes
Characters x Row:	80 x 25

### Keyboard

Number of keys:	89
Key travel:	2.5 mm (standard) 1.5 mm (optional backlight)
Function:	Emulates standard 101/102-key keyboard

### Floppy Disk Drive

Standard:	
Size:	3.5"
Capacity:	1.44MB (formatted)
Rotation:	300 RPM
Transfer Rate:	500KB/sec
Average Access:	94 ms (with settling)

### Hard Disk Drive

Type:	2.5"
Interface:	IDE Ultra DMA 33 compliant

### CD-ROM Drive

Speed:	24 x
Interface:	(ATAPI)
Data transfer rate:	16.7MB/sec
Modes:	CD-ROM mode 1 & 2, CD-Audio, VCD, Multi-session Photo CD
Dimensions:	128mm (W) x 130mm (D) x 12.7mm (H)
Weight:	280g

### Touch Screen

Type:	Capacitive or Resistive
Interface:	Serial
Resolution:	>1024x1024

## **I/O ports**

- Parallel port
- Two Serial ports
- External RGB monitor port
- External Keyboard port
- External PS/2 port
- Audio ports (External Speaker, Microphone, Line-in)
- RJ11 Phone jack for internal Fax/Modem (optional)
- RJ45 jack for internal LAN card (optional)
- 2 type II or 1 type-III PCMCIA slots
- Printer/External FDD port
- Docking port
- USB port

## **AC Adapter**

Voltage:	AC 90~240 V
Frequency:	50/60 Hz
Output Voltage:	DC 19V
Maximum Power:	90 Watts
Dimension:	130mm (W) x 60mm (D) x 34mm (H)
Weight:	430 g (0.9 lb.)

## **Vehicle Adapter**

Input Voltage	12V/24V (10~32V) Auto-sense
Input Current	2.5A/5.5A max. (12V/24V respectively)
Output Voltage	19V +/-5%
Output Current	2.8A
Wiring	Cigarette lighter/ Truck battery

---

Application                      Car or Truck installation

**Battery**

**Primary Battery:**

Type:                                9 x 18650 cells Lithium Ion  
Capacity:                           11.1V 6000mAH  
Dimension:                         103 mm(W) x 73 mm(D) x 38 mm(H)  
Weight:                              435 g (0.95 lb.)

**2<sup>nd</sup> Battery (optional):**

Type:                                9 x 18650 cells Lithium Ion  
Capacity:                           11.1V 6000mAH  
Dimension:                         150 mm(W) x 90 mm(D) x 20 mm(H)  
Weight:                              560 g (1.2 lb.)

**System Unit Dimensions and Weight**

Width:                               312mm (12.3")  
Depth:                               246mm (9.7")  
Height:                              64.5mm (2.5")  
Weight:                              5.0Kg (11 lb., 13.3" model including CD-ROM drive  
and primary battery)

*Note: Weight varies depending on system configurations.*

**Materials and Recycling**

Materials of the computer are as follows:

Cabinet:                      Aluminum alloy ADC-12 or A380,  
   Magnesium alloy AZ91D,  
   UL grade PC+ABS GE C6200 or TN-3813BW  
Bracket:                      Aluminum 5052, Steel with Nickel plating, or Stainless Steel  
   S304  
Cushion pad: Rubber  
PCB:                              FR-4, UL 94V0

Battery:	Rechargeable Lithium Ion, 9 cells per pack
Packing:	Carton: Unbleached paper Cushion: Recyclable EPE Carrying bag: Recyclable PE Fiber User's Guide: Recycled/Recyclable paper

Please recycle the parts according to local regulations.

### **Environmental**

Temperature:	0 ~ 45°C (32 ~ 113°F) operating -40 ~ 70°C (-40 ~ 158°F) storage
Humidity:	5~95% Non-condensing operating 95% maximum storage
Altitude:	0 ~ 12,180 meters (0 ~ 70,000 feet) operating

## BIOS SETUP

Press **[F2]** at boot up to enter BIOS setup. Use arrow keys to select options and **[+/-]** to modify them. When finished, move to "Exit" and press **[Enter]** then confirm save by pressing **[Y]**.

### Main Menu

Phoenix BIOS Setup Utility					
Main	Advanced	Security	Power	Boot	Exit
<b>System Time</b> [16:19:20] System Date: [03/02/2003]					Item Specific Help
Legacy Diskette A: [1.44/1.25MB3½"] Primary Master [30006MB] Secondary Master [CD-ROM]					<Tab>, <Shift-Tab>, or <Enter> selects field
System Memory: 640 KB Extended Memory: 522752 KB CPU Type Mobile Intel® Pentium® 4 CPU Speed 1800 MHz					
F1 Help    ↑↓ Select Item    -/+ Change Values    F9 Setup Defaults Esc Exit   ← Select Menu    Enter Select • Sub-Menu    F10 Save and Exit					

*Note: The contents may vary depending on computer configurations.*

### Main Menu Selections

You can make the following selections on the Main Menu. Use the sub menus for other selections.

Feature	Options	Description
System Time	HH:MM:SS	Set the system time Hour, Minute, Second.
System Date	MM/DD/YYYY	Set the system date Month, Day, Year.

Diskette 1 Diskette 2	3 ½" 1.44MB, Disabled	Select the type of floppy-disk drive installed in your system. 1.25 MB is a Japanese media format that requires a 3½" 3-Mode Diskette drive.
System Memory	N/A	Displays amount of conventional memory detected during boot up.
Extended Memory	N/A	Displays the amount of extended memory detected during boot up.
CPU Type	N/A	
CPU Speed	N/A	

**The General Help Window**

Pressing <**F1**> or <**Alt-H**> on any menu brings up the General Help window that describes in detail the keys and functions for setup.

The scroll bar on the right of any window indicates that there is more than one page of information in the window. Use <**PgUp**> and <**PgDn**> to display all the pages. Pressing <**Home**> and <**End**> displays the first and last page. Pressing <**Enter**> displays each page and then exits the window.

Press <**Esc**> to exit the current window.

**Advanced Menu**

Phoenix BIOS Setup Utility					
Main	Advanced	Security	Power	Boot	Exit
PS/2 Mouse				[Enabled]	Item Specific Help
Boot-time Diagnostic Screen:				[Enabled]	Peripheral Configuration for  COM port Parallel port
Summary Screen:				[Disabled]	
Legacy USB Support:				[Enabled]	
Default Primary Video Adapter:				[AGP]	
BootUp Display:				[Both]	
Extended Memory Test:				[Disabled]	
<b>I/O Device Configuration</b>					
F1 Help    ↑↓ Select Item    -/+ Change Values    F9 Setup Defaults Esc Exit   ← Select Menu    Enter Select ► Sub-Menu    F10 Save and Exit					

**Warning:** Incorrect settings may cause system malfunction. To correct it, restore the Setup Defaults with <F9>.

**Advanced Menu Selections**

It is usually not necessary for user to set up parameters here. Only technician may need to change the settings for diagnostic purposes.

For most frequently altered setup “I/O Device Configuration” please refer following:

**I/O Device Configuration Sub-menu**

Phoenix BIOS Setup Utility		
Advanced		
I/O Device Configuration		Item Specific Help
COM1 port:	[Enabled]	Configure COM1 device options [COM1]: External device [TTL1]: Internal device
<b>COM1 mode:</b>	<b>[COM1]</b>	
Base I/O address/IRQ:	[3F8/IRQ 4]	
COM2 port:	[Enabled]	
COM2 Mode:	[COM2]	
IrDA Mode:	[Disabled]	
Base I/O address/IRQ:	[2F8/IRQ 3]	
COM3 port:	[3E8/IRQ 10]	
COM4 port:	[2E8/IRQ 5]	

Parallel Port:	[Enabled]	
Mode:	[Bi-directional]	
Base I/O address:	[378]	
Interrupt	[IRQ 7]	
F1 Help	↑↓ Select Item	-/+ Change Values
Esc Exit	← Select Menu	Enter Select ► Sub-Menu
		F9 Setup Defaults
		F10 Save and Exit

**I/O Device Configuration Sub-menu Selections**

Please refer the on screen help for selections. BIOS shows COM3, COM4 but they are optional devices. Only when COM3/4 card is installed the function exists.

**Security Menu**

**Warning:** If you forget user/supervisor password, the computer has to send back to manufacturer and replace EEPROM to make it work again. For loss of HDD password, both the HDD and its contents cannot be recovered.

Phoenix BIOS Setup Utility					
Main	Advanced	Security	Power	Boot	Exit
<b>Set Supervisor Password:</b>		[Enter]			Item Specific Help
Set User Password:		[Enter]			Supervisor password controls access to the setup utility.
Password on boot:		[Disabled]			
Fixed disk boot sector:		[Normal]			
Set Primary Disk Password:		[Enter]			
Flash BIOS Write Protect:		[Disabled]			
F1 Help	↑↓ Select Item	-/+ Change Values			F9 Setup Defaults
Esc Exit	← Select Menu	Enter Select ► Sub-Menu			F10 Save and Exit

**Security Menu Selections**

Feature	Options	Description
Set User Password	Up to seven alphanumeric characters	Pressing <Enter> displays the dialog box for entering the user password. In related systems, this

		password gives restricted access to SETUP menus.
Set Supervisor Password	Up to seven alphanumeric characters	Pressing <Enter> displays dialog box for entering the supervisor password. In related systems, this password gives full access to Setup menus.
Password on boot	Enabled Disabled	Enabled requires a password on boot. Requires prior setting of the Supervisor password.  If supervisor password is set and this option disabled, BIOS assumes user is booting.
Fixed disk boot sector	Normal Write Protect	Write protects the boot sector on the hard disk for virus protection. Requires a password to format or FDISK the hard disk.
Set Primary Disk Password	Up to seven alphanumeric characters	

**Power Menu**

Phoenix BIOS Setup Utility					
Main	Advanced	Security	Power	Boot	Exit
<b>Lid Close Function</b>				[LCD Off]	Item Specific Help
Sleep Button Function:				[Stand By]	Select LID close function as LCD Off or Standby function
F1 Help	↑↓ Select Item	-/+ Change Values		F9 Setup Defaults	
Esc Exit	← Select Menu	Enter Select ► Sub-Menu		F10 Save and Exit	

**Boot Menu**

Phoenix BIOS Setup Utility					
Main	Advanced	Security	Power	Boot	Exit
+Removable Devices				Item Specific Help	
<b>+Hard Drive</b>				Press ↑ or ↓ to select device. Press + to move the selected device up or – to move down. Press [Enter] to show sub-menu selections. [Shift+1] enable or disable a device.	
CD-ROM Drive					
Network Boot					
F1 Help	↑↓ Select Item	-/+ Change Values		F9 Setup Defaults	
Esc Exit	← Select Menu	Enter Select • Sub-Menu		F10 Save and Exit	

The system will try boot from device on top then the 2<sup>nd</sup> and so on. If there are more than one device in each category, only the device on top of sub-menu can boot up.

**Exit Menu**

Phoenix BIOS Setup Utility					
Main	Advanced	Security	Power	Boot	Exit
<b>Exit Saving Changes</b> Exit Discarding Changes Load Setup Defaults Discard Changes Save Changes					Item Specific Help
					Exit System Setup and save your changes to CMOS.
F1 Help	↑↓ Select Item	-/+ Change Values		F9 Setup Defaults	
Esc Exit	← Select Menu	Enter Select ► Sub-Menu		F10 Save and Exit	

## UTILITIES AND DRIVERS

*Note: Most device drivers are available in Windows 98/2000/ME/XP. Only when the default driver does not work properly you need to install the factory bundled drivers.*

*The utility CD includes most drivers of the computer's installed devices. Consult dealer if any driver is missing.*

*Re-install drivers or perform "Driver Update" to replace the Windows default drivers.*

### VGA Utility

#### Display Capability

Resolution & Color	LCD	RGB	LCD + RGB
640x 480x 16-bit color	<input type="radio"/>	<input type="radio"/>	<input type="radio"/>
640x 480x 24-bit color	<input type="radio"/>	<input type="radio"/>	<input type="radio"/>
640x 480x 32-bit color	<input type="radio"/>	<input type="radio"/>	<input type="radio"/>
800x 600x 64K color	<input type="radio"/>	<input type="radio"/>	<input type="radio"/>
800x 600x 24-bit color	<input type="radio"/>	<input type="radio"/>	<input type="radio"/>
800x 600x 32-bit color	<input type="radio"/>	<input type="radio"/>	<input type="radio"/>
1024x 768x 16-bit color	<input type="radio"/>	<input type="radio"/>	<input type="radio"/>
1024x 768x 24-bit color	<input type="radio"/>	<input type="radio"/>	<input type="radio"/>
1024x 768x 24-bit color	<input type="radio"/>	<input type="radio"/>	<input type="radio"/>
1280x 1024x 16-bit color	<input type="radio"/> *	<input type="radio"/>	<input type="radio"/> *
1280x 1024x 24-bit color	<input type="radio"/> *	<input type="radio"/>	<input type="radio"/> *
1280x 1024x 32-bit color	<input type="radio"/> *	<input type="radio"/>	<input type="radio"/> *
1600x 1200x 16-bit color	<input type="radio"/> *	<input type="radio"/>	<input type="radio"/> *

1600x 1200x 24-bit color	<input type="radio"/> *	<input type="radio"/>	<input type="radio"/> *
1600x 1200x 32-bit color	<input type="radio"/> *	<input type="radio"/>	<input type="radio"/> *
2048x 1536x 16-bit color	<input type="radio"/> *	<input type="radio"/>	<input type="radio"/> *
2048x 1536x 24-bit color	<input type="radio"/> *	<input type="radio"/>	<input type="radio"/> *
2048x 1536x 32-bit color	<input type="radio"/> *	<input type="radio"/>	<input type="radio"/> *

\*: By Panning.

The table lists typical display modes only. The system also supports standard video modes with lower resolution and color.

**Windows 98/2000/ME/XP Driver Installation:**

Insert the Driver CD into the CD-ROM. Click **Display** in **Control Panel** then select **Settings**, follow prompt to complete driver installation. Windows 98/2000/ME/XP may recommend using their driver, but you should confirm changing to the factory bundled driver.

Back to **Settings** window, choose proper **Colors** and **Screen Area**, then click **OK** and restart Windows.

**Mouse Driver**

The mouse driver is not included in utilities It is usually not necessary to install a mouse driver because the operating system will do it automatically.

You may obtain mouse driver from the dealer if it's really needed.

**Touch Screen Driver**

First please enter BIOS Setup and set COM1 port as "TTL1". (COM1 has multiple connectivity so it's necessary to setup. Optional COM4 may be configured as touch screen and doesn't need BIOS setup.)

Then install the drivers under Windows by **Add Hardware**.

**CD-ROM Driver**

In Windows 98/2000/ME/XP, you don't need to install drivers, because it is included in the drivers list.

Only non-Windows OS need the driver

## **PCMCIA Driver**

### **Windows 98/2000/ME/XP**

The driver is automatically installed under Windows.

Windows 98/2000/ME/XP can also detect new PCMCIA cards or by **Add Hardware**. You simply insert your PCMCIA card and click the icon, then follow the prompt to complete the installation.

### **Audio Driver**

In Windows 98/2000/ME/XP click **System** → **Hardware** → **Device Manager** → choose **Sound, video and game controllers**, then choose audio device to update driver.

In Windows NT, Click **Multimedia** → **Peripheral** → **Driver** to install it.

### **LAN Card Driver**

In Windows 98/2000/ME/XP click **System** → **Hardware** → **Device Manager** → choose **Network adapters**, then choose the appropriate device and click **Driver** → **Update Driver**. Follow the prompt to complete installation.

### **Fax/Modem Card Driver**

Windows 98/2000/ME/XP will detect Fax/Modem card as new hardware and begin driver installation.

## MAINTENANCE / SERVICE

### Cleaning

ALWAYS turn OFF the power, unplug the power cord and remove the battery before cleaning.

The exterior of the system and display may be wiped with a clean, soft, and lint-free cloth. If there is difficulty removing dirt, apply non-ammonia, non-alcohol based glass cleaner to the cloth and wipe.

An air gun is recommended for cleaning water and dust. For salty water please clean with fresh water then blow-dry with an air gun. Be sure not to turn the computer up side down while there is water being applied.

### Troubleshooting

Should the computer fail to function properly, the troubleshooting steps below may be followed.

- Check AC/vehicle adapter, battery, and the power source.
- Minimize the configuration, i.e., remove extra peripherals and devices.
- Remove the modules one by one (HDD, CD-ROM, FDD, Battery, etc.).
- Remove the software suspected.
- Set BIOS fail-safe default.
- Re-install operating system and application software.

### RMA Service

If troubleshooting steps are unsuccessful, consult your dealer for service. If it is necessary for you to send in your computer for repairs, a representative from your authorized technical support department will provide you with an RMA#. Only after you have spoken with a technical support representative and received an RMA# should you send in your computer.

Shipping instructions:

1. Remove any personal diskettes, CD's, or other media.
2. Use the original shipping container and packing materials, if possible.

3. If the original packing materials are not available, wrap the equipment with soft material (e.g., PU/ PE form) then put the wrapped equipment into a hard cardboard shipping box.
4. Include a sheet with the following information: (Note: please keep a copy of this sheet for your records)
  - Name
  - Address
  - Unit serial number
  - Place and date of purchase or the original invoice number
  - Date of failure
  - A DETAILED Description of the problems you have encountered
  - A list of the hardware/software configuration, if applicable.
5. Clearly mark the outside of the shipping box with the RMA #. If an RMA # is not present on the shipping box, receiving will be unable to identify it and it might be returned.
6. Unless prior arrangements have been made, the customer is responsible for all shipping costs. Unauthorized use of the company's shipping accounts is not permitted.

Recycled / Recycleable  
Printed in Taiwan